

Approval body for construction products  
and types of construction

Bautechnisches Prüfamt

An institution established by the Federal and  
Laender Governments



## European Technical Assessment

ETA-19/0204  
of 2 December 2020

English translation prepared by DIBt - Original version in German language

### General Part

Technical Assessment Body issuing the  
European Technical Assessment:

Deutsches Institut für Bautechnik

Trade name of the construction product

Mungo Injection system MIT700RE  
for rebar connection

Product family  
to which the construction product belongs

Systems for post-installed rebar  
connections with mortar

Manufacturer

Mungo Befestigungstechnik AG  
Bornfeldstrasse 2  
4603 OLTEN  
SCHWEIZ

Manufacturing plant

Werk 13 / Plant 13

This European Technical Assessment  
contains

22 pages including 3 annexes which form an integral part  
of this assessment

This European Technical Assessment is  
issued in accordance with Regulation (EU)  
No 305/2011, on the basis of

EAD 330087-00-0601, Edition 05/2018

The European Technical Assessment is issued by the Technical Assessment Body in its official language. Translations of this European Technical Assessment in other languages shall fully correspond to the original issued document and shall be identified as such.

Communication of this European Technical Assessment, including transmission by electronic means, shall be in full. However, partial reproduction may only be made with the written consent of the issuing Technical Assessment Body. Any partial reproduction shall be identified as such.

This European Technical Assessment may be withdrawn by the issuing Technical Assessment Body, in particular pursuant to information by the Commission in accordance with Article 25(3) of Regulation (EU) No 305/2011.

**Specific Part**

**1 Technical description of the product**

The subject of this European Technical Assessment is the post-installed connection, by anchoring or overlap connection joint, of reinforcing bars (rebars) in existing structures made of normal weight concrete, using the "Mungo Injection System MIT700RE for rebar connection" in accordance with the regulations for reinforced concrete construction.

Reinforcing bars made of steel with a diameter  $\phi$  from 8 to 40 mm or the tension anchor from sizes M12 to M24 according to Annex A and injection mortar MIT700RE are used for rebar connections. The rebar is placed into a drilled hole filled with injection mortar and is anchored via the bond between rebar, injection mortar and concrete.

The product description is given in Annex A.

**2 Specification of the intended use in accordance with the applicable European assessment Document**

The performances given in Section 3 are only valid if the anchor is used in compliance with the specifications and conditions given in Annex B.

The verifications and assessment methods on which this European Technical Assessment is based lead to the assumption of a working life of the rebar connection of at least 50 years. The indications given on the working life cannot be interpreted as a guarantee given by the producer, but are to be regarded only as a means for choosing the right products in relation to the expected economically reasonable working life of the works.

**3 Performance of the product and references to the methods used for its assessment**

**3.1 Mechanical resistance and stability (BWR 1)**

Essential characteristic	Performance
Characteristic resistance under static and quasi-static loading	See Annex C 1

**3.2 Safety in case of fire (BWR 2)**

Essential characteristic	Performance
Reaction to fire	Class A1
Resistance to fire	See Annex C 2 and C 3

**4 Assessment and verification of constancy of performance (AVCP) system applied, with reference to its legal base**

In accordance with European Assessment Document EAD No. 330087-00-0601, the applicable European legal act is: [96/582/EC].

The system(s) to be applied is (are): 1

**5 Technical details necessary for the implementation of the AVCP system, as provided for in the applicable European Assessment Document**

Technical details necessary for the implementation of the AVCP system are laid down in the control plan deposited with Deutsches Institut für Bautechnik.

Issued in Berlin on 2 December 2020 by Deutsches Institut für Bautechnik

Dipl.-Ing. Beatrix Wittstock  
Head of Section

*beglaubigt:*  
Baderschneider

### Installation post installed rebar

**Figure A1:** Overlapping joint for rebar connections of slabs and beams

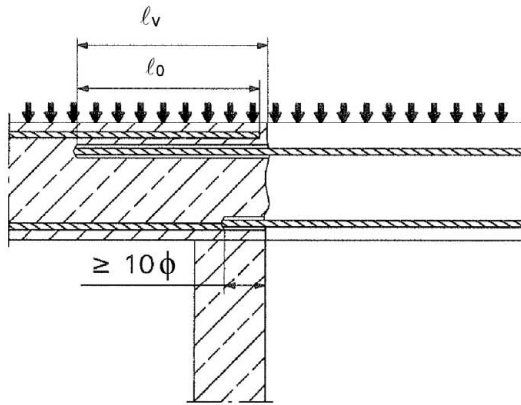

**Figure A3:** End anchoring of slabs or beams (e.g. designed as simply supported)

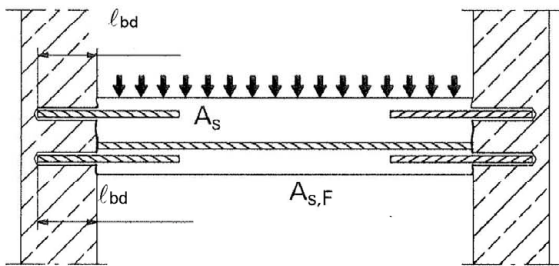

**Figure A5:** Anchoring of reinforcement to cover the line of acting tensile force

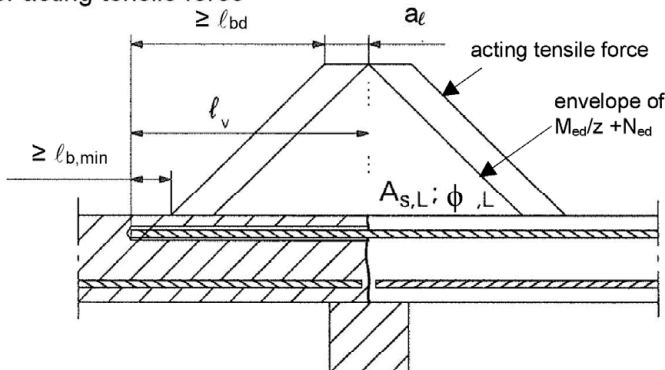

**Figure A2:** Overlapping joint at a foundation of a wall or column where the rebars are stressed in tension

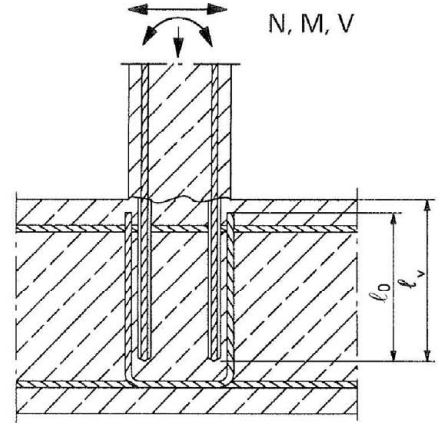

**Figure A4:** Rebar connection for components stressed primarily in compression. The rebars are stressed in compression

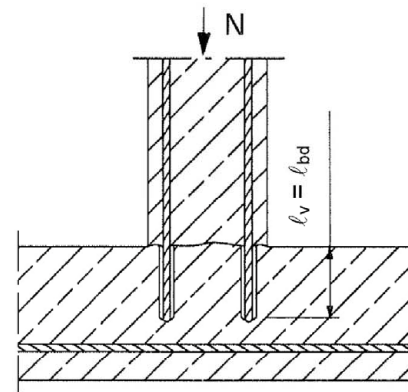

**Note to Figure A1 to A5:**

In the Figures no transverse reinforcement is plotted, the transverse reinforcement shall comply with EN 1992-1-1:2004+AC:2010.

Preparing of joints according to Annex B 2

Mungo Injection system MIT700RE for rebar connection

**Product description**  
Installed condition and examples of use for rebars

**Annex A 1**

## Installation tension anchor ZA

**Figure A6:** Overlapping joint of a column stressed in bending to a foundation

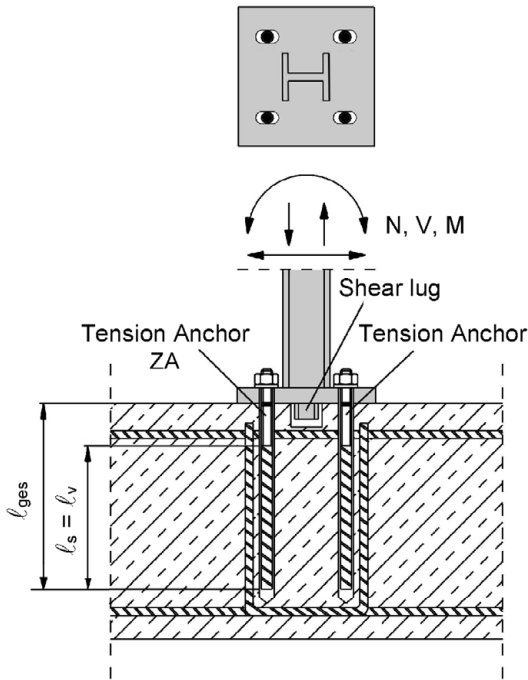

**Figure A7:** Overlap joint for the anchorage of barrier posts

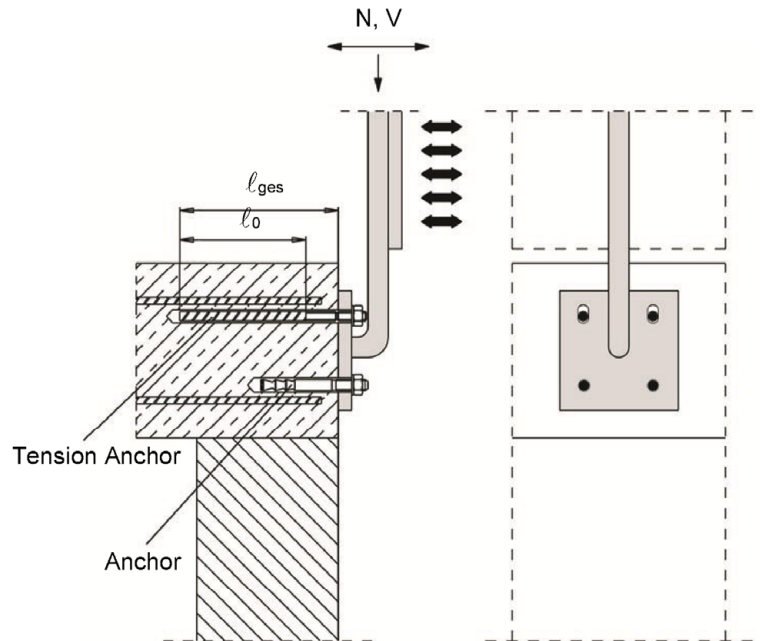

**Figure A8:** Overlap joint for the anchorage to cantilever members

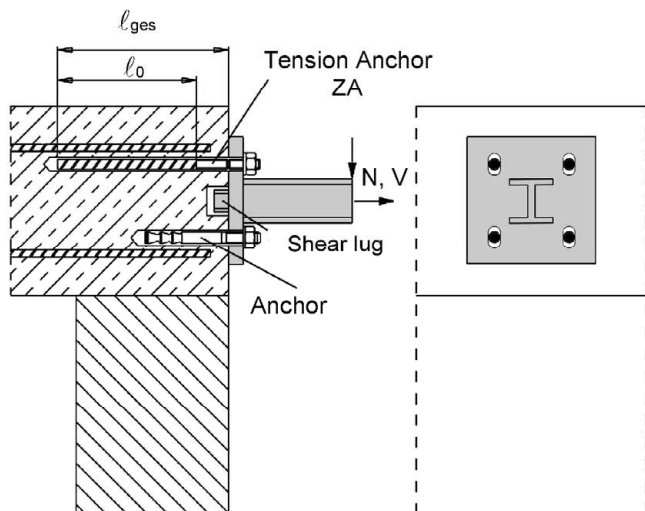

### Note to Figure A6 to A8:

In the Figures no transverse reinforcement is plotted, the transverse reinforcement shall comply with EN 1992-1-1:2002+AC:2010

Mungo Injection system MIT700RE for rebar connection

#### Product description

Installed condition and examples of use for tension anchors ZA

Annex A 2

**Mungo Injection system MIT700RE:**

**Injection mortar: MIT700RE**

**Type "side-by-side":**  
440ml, 585 ml and 1400 ml  
cartridge

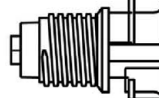

Imprint: MIT700RE,  
processing notes, charge-code, shelf life,  
hazard-code, curing- and processing time  
(depending on the temperature), Optional with  
travel scale

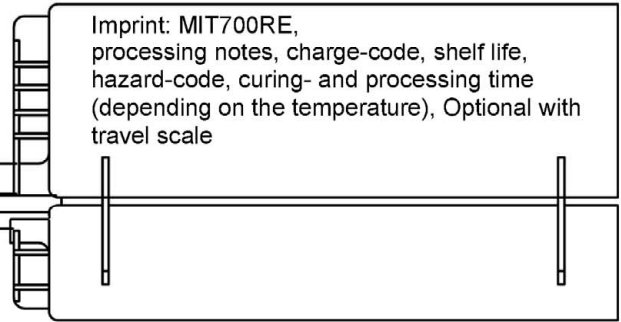

**Static Mixer**

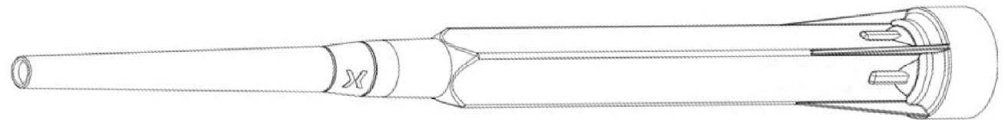

**Piston plug and mixer  
extension**

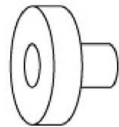

**Reinforcing bar (rebar):  $\varnothing 8$ ,  $\varnothing 10$ ,  $\varnothing 12$ ,  $\varnothing 14$ ,  $\varnothing 16$ ,  $\varnothing 20$ ,  $\varnothing 22$ ,  $\varnothing 24$ ,  $\varnothing 25$ ,  $\varnothing 28$ ,  $\varnothing 32$ ,  $\varnothing 34$ ,  $\varnothing 36$ ,  $\varnothing 40$**



**Tension Anchor ZA: M12 to M24**

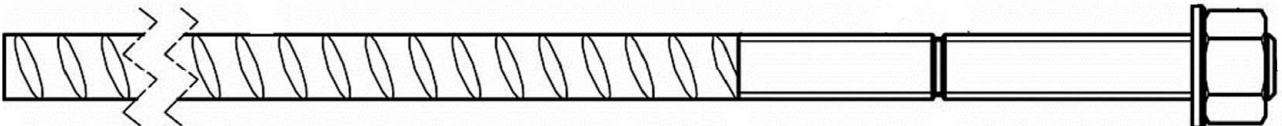

**Mungo Injection system MIT700RE for rebar connection**

**Product description**  
Injection mortar / Static mixer / Rebar / Tension Anchor ZA

**Annex A 3**

**Reinforcing bar (rebar):  $\phi 8$ ,  $\phi 10$ ,  $\phi 12$ ,  $\phi 14$ ,  $\phi 16$ ,  $\phi 20$ ,  $\phi 22$ ,  $\phi 24$ ,  $\phi 25$ ,  $\phi 28$ ,  $\phi 32$ ,  $\phi 34$ ,  $\phi 36$ ,  $\phi 40$**



- Minimum value of related rip area  $f_{R,min}$  according to EN 1992-1-1:2004+AC:2010
- Rib height of the bar shall be in the range  $0,05\phi \leq h_{rib} \leq 0,07\phi$   
( $\phi$ : Nominal diameter of the bar;  $h_{rib}$ : Rib height of the bar)

**Table A1: Materials**

Designation	Material
Rebar EN 1992-1-1:2004+AC:2010, Annex C	Bars and de-coiled rods class B or C $f_{yk}$ and $k$ according to NDP or NCL of EN 1992-1-1/NA $f_{uk} = f_{tk} = k \cdot f_{yk}$
<b>Mungo Injection system MIT700RE for rebar connection</b>	<b>Annex A 4</b>
Product description Materials Rebar	



### Tension Anchor ZA: M12, M16, M20, M24

Marking: e.g.  ZA 12 A4

-  Mark of the producer
- ZA Trade name
- 12 Rod diameter/thread
- A4 for stainless steel A4
- HCR for high corrosion resistance steel

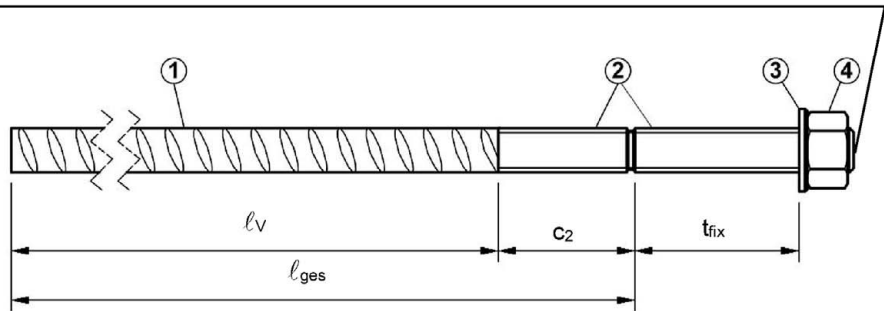

**Table A2: Materials**

Part	Designation	Material											
		ZA vz				ZA A4				ZA HCR			
		M12	M16	M20	M24	M12	M16	M20	M24	M12	M16	M20	M24
1	Reinforcement bar	Class B according to NDP or NCL of EN 1992-1-1/NA $f_{uk} = f_{tk} = k \cdot f_{yk}$											
2	Threaded rod	Steel, zinc plated according to EN 10087:1998 or EN 10263:2001				Stainless steel, 1.4362, 1.4401, 1.4404, 1.4571, EN 10088-1:2014				High corrosion resistant steel, 1.4529, 1.4565, EN 10088-1:2014			
		$f_{yk}$ [N/mm <sup>2</sup> ]											
		640				640				560			
3	Washer	Steel, zinc plated according to EN 10087:1998 or EN 10263:2001				Stainless steel, 1.4362, 1.4401, 1.4404, 1.4571, EN 10088-1:2014				High corrosion resistant steel, 1.4529, 1.4565, EN 10088-1:2014			
4	Nut												

**Table A3: Dimensions and installation parameter**

Size			ZA-M12	ZA-M16	ZA-M20	ZA-M24	
Diameter of threaded rod	$d_s$	[mm]	12	16	20	24	
Diameter of reinforcement bar	$\phi$	[mm]	12	16	20	25	
Drill hole diameter	$d_o$	[mm]	16	20	25	32	
Diameter of clearance hole in fixture	$d_f$	[mm]	14	18	22	26	
With across nut flats	SW	[mm]	19	24	30	36	
Stress area	$A_s$	[mm <sup>2</sup> ]	84	157	245	353	
Effective embedment depth	$l_v$	[mm]	according to static calculation				
Length of bonded thread	plated	$c_2$	[mm]	$\geq 20$	$\geq 20$	$\geq 20$	$\geq 20$
	A4/HCR			$\geq 100$	$\geq 100$	$\geq 100$	$\geq 100$
Minimum thickness of fixture	$t_{fix}$	[mm]	5	5	5	5	
Maximum thickness of fixture	$t_{fix}$	[mm]	3000	3000	3000	3000	
Maximum installation torque	$T_{max}$	[Nm]	50	100	150	150	

**Mungo Injection system MIT700RE for rebar connection**

**Product description**  
Specifications Tension Anchor ZA

**Annex A 5**

## Specifications of intended use

### Anchorage subject to:

- Static and quasi-static loads.
- Fire exposure

### Base materials:

- Reinforced or unreinforced normal weight concrete according to EN 206:2013 + A1:2016.
- Strength classes C12/15 to C50/60 according to EN 206:2013 + A1:2016.
- Maximum chloride content of 0,40% (CL 0.40) related to the cement content according to EN 206:2013 + A1:2016.
- Non-carbonated concrete.

Note: In case of a carbonated surface of the existing concrete structure the carbonated layer shall be removed in the area of the post-installed rebar connection with a diameter of  $\phi + 60$  mm prior to the installation of the new rebar.

The depth of concrete to be removed shall correspond to at least the minimum concrete cover in accordance with EN 1992-1-1:2004+AC:2010.

The foregoing may be neglected if building components are new and not carbonated and if building components are in dry conditions.

### Temperature Range:

- - 40°C to +80°C (max. short term temperature +80°C and max long term temperature +50°C).

### Use conditions (Environmental conditions) with tension anchor ZA:

- Structures subject to dry internal conditions or subject to external atmospheric exposure (including industrial and marine environment) and to permanently damp internal condition, if no particular aggressive conditions exist (stainless steel or high corrosion resistant steel).
- Structures subject to external atmospheric exposure and to permanently damp internal condition, if other particular aggressive conditions exist (high corrosion resistant steel).

Note: Particular aggressive conditions are e.g. permanent, alternating immersion in seawater or the splash zone of seawater, chloride atmosphere of indoor swimming pools or atmosphere with extreme chemical pollution (e.g. in desulphurization plants or road tunnels where de-icing materials are used).

### Design:

- Anchorages are designed under the responsibility of an engineer experienced in anchorages and concrete work.
- Verifiable calculation notes and drawings are prepared taking account of the forces to be transmitted.
- Design according to EN 1992-1-1:2004+AC:2010, EN 1992-1-2:2004+AC:2008 and Annex B 2 and B 3.
- The actual position of the reinforcement in the existing structure shall be determined on the basis of the construction documentation and taken into account when designing.

### Installation:

- Dry or wet concrete.
- It must not be installed in flooded holes.
- Hole drilling by hammer drill (HD), hollow drill (HDB), diamond drill (DD) or compressed air drill (CD).
- The installation of post-installed rebar resp. tension anchors shall be done only by suitable trained installer and under supervision on site; the conditions under which an installer may be considered as suitable trained and the conditions for supervision on site are up to the Member States in which the installation is done.
- Check the position of the existing rebars (if the position of existing rebars is not known, it shall be determined using a rebar detector suitable for this purpose as well as on the basis of the construction documentation and then marked on the building component for the overlap joint).

**Mungo Injection system MIT700RE for rebar connection**

**Intended use  
Specifications**

**Annex B 1**

**Figure B1: General construction rules for post-installed rebars**

- Only tension forces in the axis of the rebar may be transmitted
- The transfer of shear forces between new concrete and existing structure shall be designed additionally according to EN 1992-1-1:2004+AC:2010.
- The joints for concreting must be roughened to at least such an extent that aggregate protrude.

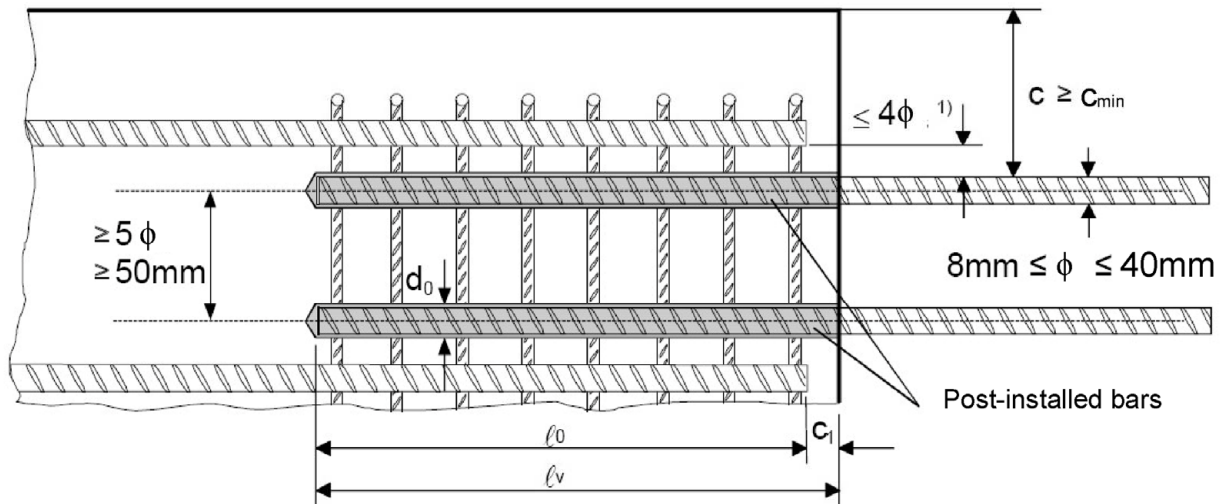

- 1) If the clear distance between lapped bars exceeds  $4\phi$ , then the lap length shall be increased by the difference between the clear bar distance and  $4\phi$ .

The following applies to Figure B1:

c	concrete cover of post-installed rebar
$c_1$	concrete cover at end-face of existing rebar
$c_{min}$	minimum concrete cover according to Table B1 and to EN 1992-1-1:2004+AC:2010, Section 4.4.1.2
$\phi$	diameter of post-installed rebar
$l_0$	lap length, according to EN 1992-1-1:2004+AC:2010, Section 8.7.3
$l_v$	effective embedment depth, $\geq l_0 + c_1$
$d_0$	nominal drill bit diameter, see Annex B 4

**Mungo Injection system MIT700RE for rebar connection**

**Intended use**  
General construction rules for post-installed rebars

**Annex B 2**

**Figure B2: General construction rules for tension anchors ZA**

- The length of the bonded-in thread may not be accounted as anchorage
- Only tension forces in the direction of the bar axis may be transmitted by the tension anchor ZA
- The tension force must be transferred via an overlap joint to the reinforcement in the building part.
- The transfer of shear forces shall be ensured by appropriate additional measures, e.g. shear lugs or by anchors with an European technical assessment.
- In the anchor plate, the holes for the tension anchors shall be executed as elongated holes with axis in the direction of the shear force.

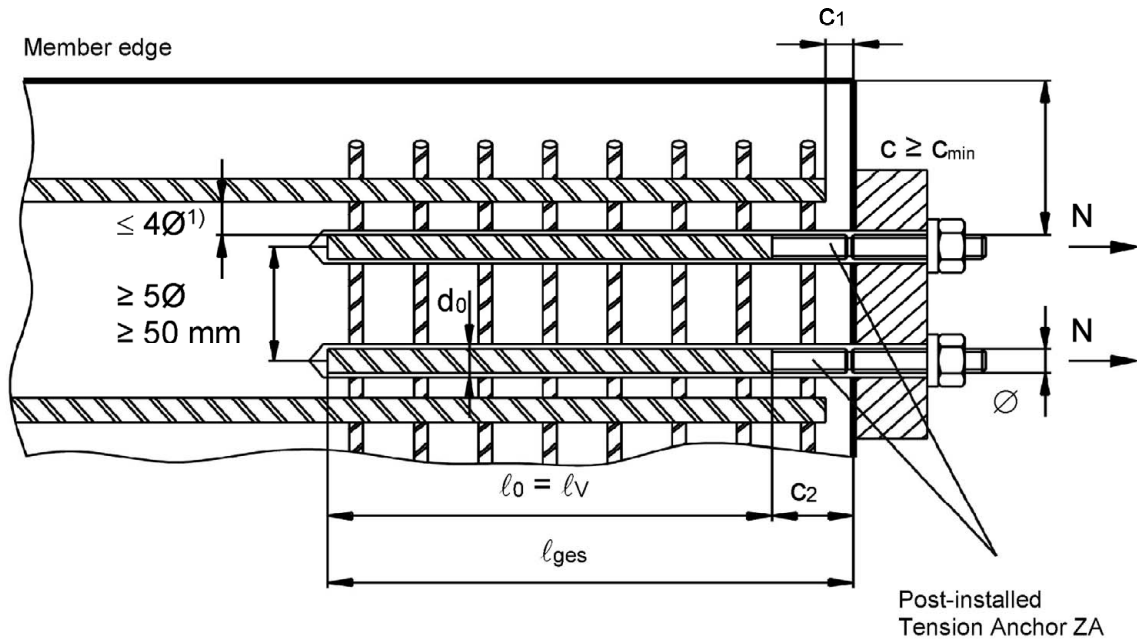

- 1) If the clear distance between lapped bars exceeds  $4\phi$ , then the lap length shall be increased by the difference between the clear bar distance and  $4\phi$ .

The following applies to Figure B2:

c	concrete cover of tension anchor ZA
$c_1$	concrete cover at end-face of existing rebar
$c_2$	Length of bonded thread
$c_{min}$	minimum concrete cover according to Table B1 and to EN 1992-1-1:2004+AC:2010, Section 4.4.1.2
$\phi$	diameter of tension anchor
$l_0$	lap length, according to EN 1992-1-1:2004+AC:2010, Section 8.7.3
$l_v$	effective embedment depth, $\geq l_0 + c_1$
$l_{ges}$	overall embedment depth, $\geq l_0 + c_2$
$d_0$	nominal drill bit diameter, see Annex B 4

**Mungo Injection system MIT700RE for rebar connection**

**Intended use**  
General construction rules for tension anchors

**Annex B 3**

**Table B1: Minimum concrete cover min  $c^1$ ) of post-installed rebar and tension anchor ZA depending of drilling method**

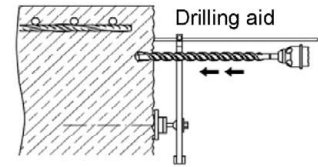

Drilling method	Rebar diameter	Without drilling aid	With drilling aid
Hammer drilling (HD) Hollow drilling (HDB)	< 25 mm	$30 \text{ mm} + 0,06 \cdot l_v \geq 2 \phi$	$30 \text{ mm} + 0,02 \cdot l_v \geq 2 \phi$
	$\geq 25 \text{ mm}$	$40 \text{ mm} + 0,06 \cdot l_v \geq 2 \phi$	$40 \text{ mm} + 0,02 \cdot l_v \geq 2 \phi$
Diamond drilling (DD)	< 25 mm	Drill rig used as drilling aid	$30 \text{ mm} + 0,02 \cdot l_v \geq 2 \phi$
	$\geq 25 \text{ mm}$		$40 \text{ mm} + 0,02 \cdot l_v \geq 2 \phi$
Compressed air drilling (CD)	< 25 mm	$50 \text{ mm} + 0,08 \cdot l_v$	$50 \text{ mm} + 0,02 \cdot l_v$
	$\geq 25 \text{ mm}$	$60 \text{ mm} + 0,08 \cdot l_v$	$60 \text{ mm} + 0,02 \cdot l_v$

<sup>1)</sup> see Annex B 2, Figure B1 and Annex B 3, Figure B2

Comments: The minimum concrete cover acc. EN 1992-1-1:2004+AC:2010 must be observed

**Table B2: maximum embedment depth  $l_{v,max}$**



Rebar $\phi$	Tension anchor $\phi$	HD / CD / DD $l_{v,max}$ [mm]	HDB $l_{v,max}$ [mm]
8 mm		800	800
10 mm		1000	1000
12 mm	ZA-M12	1200	1000
14 mm		1400	1000
16 mm	ZA-M16	1600	1000
20 mm	ZA-M20	2000	1000
22 mm		2000	1000
24 mm		2000	1000
25 mm	ZA-M24	2000	1000
28 mm		2000	1000
32 mm		2000	1000
34 mm		2000	-
36 mm		2000	-
40 mm		2000	-

**Table B3: Base material temperature, gelling time and curing time**

Concrete temperature	Gelling- / working time <sup>1)</sup> $t_{gel}$	Minimum curing time in dry concrete $t_{cure,dry}$	Minimum curing time in wet concrete $t_{cure,wet}$
+ 5 °C to + 9 °C	80 min	48 h	96 h
+ 10 °C to + 14 °C	60 min	28 h	56 h
+ 15 °C to + 19 °C	40 min	18 h	36 h
+ 20 °C to + 24 °C	30 min	12 h	24 h
+ 25 °C to + 34 °C	12 min	9 h	18 h
+ 35 °C to + 39 °C	8 min	6 h	12 h
+40 °C	8 min	4 h	8 h
Cartridge temperature	+5 °C to +40 °C		

<sup>1)</sup>  $t_{gel}$ : maximum time from starting of mortar injection to completing of rebar setting.

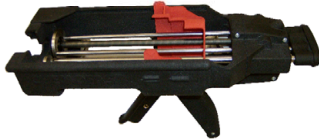
<b>Mungo Injection system MIT700RE for rebar connection</b>	<b>Annex B 4</b>
Intended use Minimum concrete cover Maximum embedment depth	

Table B4: Dispensing tools			
Cartridge type/size	Hand tool		Pneumatic tool
Side-by-side cartridges 440, 585 ml	 e.g. MIT-PP-H2 (440/585)	 e.g. MIT-PP-H0	 e.g. MIT-PP-P (440/585)
Side-by-side cartridges 1400 ml	-	-	 e.g. MIT-PP-P (1400)

  

### Cleaning and installation tools

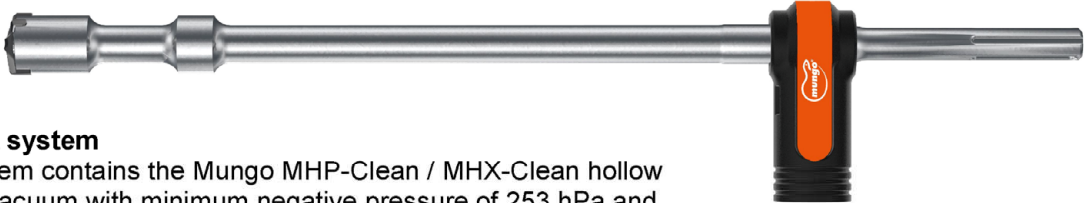

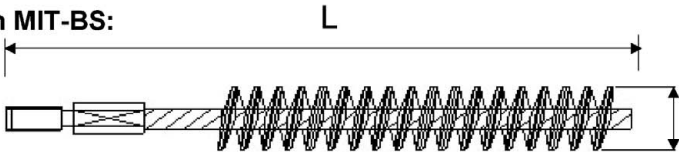

**HDB – Hollow drill bit system**  
The hollow drill bit system contains the Mungo MHP-Clean / MHX-Clean hollow drill bit and a class M vacuum with minimum negative pressure of 253 hPa and flow rate of minimum 150 m<sup>3</sup>/h (42 l/s).

**Brush MIT-BS:**



**SDS Plus Adapter:**

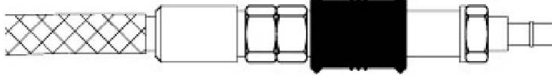

**Brush extension:** 

**Rec. compressed air tool hand slide valve (min 6 bar)** 

<b>Mungo Injection system MIT700RE for rebar connection</b>	<b>Annex B 5</b>
<b>Intended Use</b> Dispensing, cleaning and installation tools	

**Table B5: Brushes, piston plugs, max anchorage depth and mixer extension, hammer (HD), diamond (DD) and compressed air (CD) drilling**

Bar size $\phi$	Tension anchor $\phi$	Drill bit - $\emptyset$			$d_b$ Brush - $\emptyset$		$d_{b,min}$ min. Brush - $\emptyset$	Piston plug	Cartridge: 440 ml or 585 ml				Cartridge: 1400 ml		
		HD	DD	CD	MIT-	Hand or battery tool			Pneumatic tool		Pneumatic tool				
						$l_{v,max}$			Mixer extension	$l_{v,max}$	Mixer extension	$l_{v,max}$	Mixer extension		
[mm]	[mm]	[mm]			MIT-	[mm]	[mm]	MIT-	[mm]	MIT-	[mm]	MIT-	[mm]	MIT-	
8	-	10	-		BS10	11,5	10,5	-	250	MI-V1/ MI-V2	250	MI-V1/ MI-V2	250	MI-V1/ MI-V2	
	-	12	-		BS12	13,5	12,5	-	700		800		800		
10	-	14	-		BS14	15,5	14,5	VS14	250		250		250		
	-		700	1000					1000						
12	ZA-M12	16	-		BS16	17,5	16,5	VS16	250		1300		250		1200
14	-		18	-									BS18		
16	ZA-M16	20	-		BS20	22,0	20,5	VS20	700		1300				1600
20	ZA-M20	25	-										BS25		27,0
	-	26	-		BS26	28,0	26,5	VS25							
22	-	28	-						BS28		30,0		28,5		VS28
24/25	ZA-M24	32	-		BS32	34,0	32,5	VS32							
28	-	35	-						BS35	37,0	35,5	VS35			
32/34	-	40	-		BS40	43,5	40,5	VS40							
36	-	45	-						BS45	47,0	45,5	VS45			
40	-	-	52	-	BS52	54,0	52,5	VS52					-	-	-
		55	-	55					BS55	58,0	55,5	VS55			

**Table B6: Brushes, piston plugs, max anchorage depth and mixer extension, hammer drilling with hollow drill bit system (HDB)**

Bar size $\phi$	Tension anchor $\phi$	Drill bit - $\emptyset$	$d_b$ Brush - $\emptyset$	$d_{b,min}$ min. Brush - $\emptyset$	Piston plug	Cartridge: 440 ml or 585 ml				Cartridge: 1400 ml		
		HDB				Hand or battery tool		Pneumatic tool		Pneumatic tool		
						$l_{v,max}$	Mixer extension	$l_{v,max}$	Mixer extension	$l_{v,max}$	Mixer extension	
[mm]	[mm]	[mm]			MIT-	[mm]	MIT-	[mm]	MIT-	[mm]	MIT-	
8	-	10	No cleaning required		MIT-	250	MI-V1/ MI-V2	1000	MI-V1/ MI-V2	250	MI-V1/ MI-V2	
	-	12			-	700				800		800
10	-				14	-				250		250
	-	VS14				700				1000		1000
12	ZA-M12	16			VS16	250				250		
14	-				VS18	700				1000		1000
16	ZA-M16	20			VS20	500				1000		1000
20	ZA-M20	25			VS25							
22	-	28			VS28							
24/25	ZA-M24	32			VS32							
28	-	35			VS35							
32/34	-	40			VS40							

Mungo Injection system MIT700RE for rebar connection

Intended use  
Installation tools

Annex B 6

## A) Bore hole drilling

Note: Before drilling, remove carbonated concrete and clean contact areas (see Annex B1)  
In case of aborted drill hole: the drill hole shall be filled with mortar.

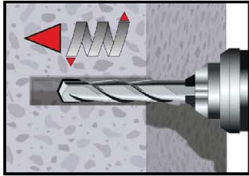

- 1a. Hammer (HD) or compressed air drilling (CD)**  
Drill a hole into the base material to the size and embedment depth required by the selected reinforcing bar  
Proceed with Step B1.



Hammer drill (HD + HDB)

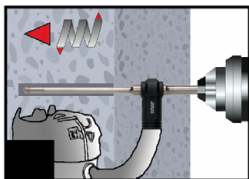

- 1b. Hollow drill bit system (HDB) (see Annex B 5)**  
Drill a hole into the base material to the size and embedment depth required by the selected reinforcing bar.  
This drilling system removes the dust and cleans the bore hole during drilling. Proceed with Step C.

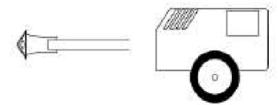

Compressed air drill (CD)

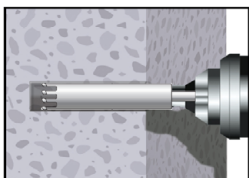

- 1c. Diamond drilling (DD)**  
Drill with diamond drill a hole into the base material to the size and embedment depth required by the selected anchor  
Proceed with Step B2.

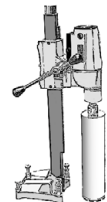

Diamond coring (DD)

## B1) Bore hole cleaning

**CAC: Cleaning for all bore hole diameter and bore hole depth with drilling method HD and CD**

**Attention! Standing water in the bore hole must be removed before cleaning.**

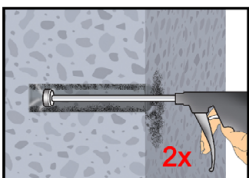

- 2a.** Starting from the bottom or back of the bore hole, blow the hole clean with compressed air (min. 6 bar) (Annex B 7) a minimum of two times until return air stream is free of noticeable dust. If the bore hole ground is not reached an extension shall be used

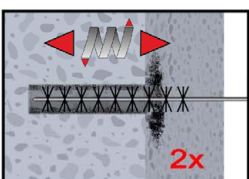

- 2b.** Check brush diameter (Table B5). Brush the hole with an appropriate sized wire brush  $> d_{b,min}$  (Table B5) a minimum of two times.  
If the bore hole ground is not reached with the brush, a brush extension shall be used (Table B5).

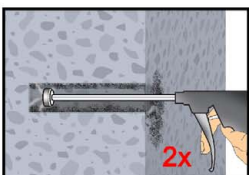

- 2c.** Finally blow the hole clean again with compressed air (min. 6 bar) (Annex B 7) a minimum of two times until return air stream is free of noticeable dust. If the bore hole ground is not reached an extension shall be used.

**After cleaning, the bore hole has to be protected against re-contamination in an appropriate way, until dispensing the mortar in the bore hole. If necessary, the cleaning has to be repeated directly before dispensing the mortar. In-flowing water must not contaminate the bore hole again.**

**Mungo Injection system MIT700RE for rebar connection**

**Intended use**

Installation instruction: Bore hole drilling and cleaning (HD, HDB and CD)

**Annex B 7**



## B2) Bore hole cleaning

### SPCAC: Cleaning for all bore hole diameter and bore hole depth with drilling method DD

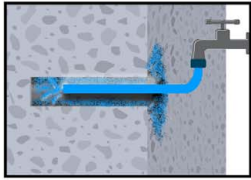

2a. Rinsing with water until clear water comes out.

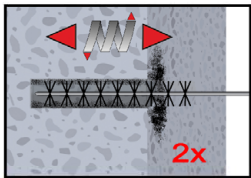

2b. Check brush diameter (Table B5). Brush the hole with an appropriate sized wire brush  $> d_{b,min}$  (Table B5) a minimum of two times in a twisting motion. If the bore hole ground is not reached with the brush, a brush extension must be used.

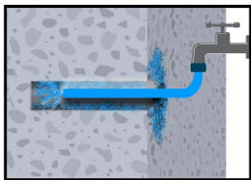

2c. Rinsing again with water until clear water comes out.

**Attention! Standing water in the bore hole must be removed before proceed cleaning.**

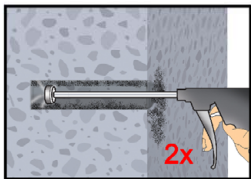

2d. Starting from the bottom or back of the bore hole, blow the hole clean with compressed air (min. 6 bar) (Annex B 7) a minimum of two times until return air stream is free of noticeable dust. If the bore hole ground is not reached an extension shall be used

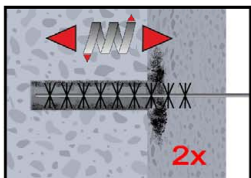

2e. Check brush diameter (Table B5). Brush the hole with an appropriate sized wire brush  $> d_{b,min}$  (Table B5) a minimum of two times. If the bore hole ground is not reached with the brush, a brush extension shall be used (Table B5).

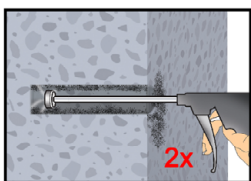

2f. Finally blow the hole clean again with compressed air (min. 6 bar) (Annex B 7) a minimum of two times until return air stream is free of noticeable dust. If the bore hole ground is not reached an extension shall be used.

**After cleaning, the bore hole has to be protected against re-contamination in an appropriate way, until dispensing the mortar in the bore hole. If necessary, the cleaning has to be repeated directly before dispensing the mortar. In-flowing water must not contaminate the bore hole again.**

Mungo Injection system MIT700RE for rebar connection

Intended use

Installation instruction: Bore hole drilling and cleaning (DD)

**Annex B 8**

### C) Preparation of bar and cartridge

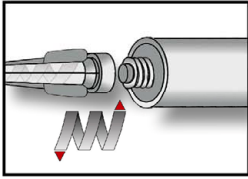

- 3a. Attach the supplied static-mixing nozzle to the cartridge and load the cartridge into the correct dispensing tool.  
For every working interruption longer than the recommended working time (Table B3) as well as for every new cartridges, a new static-mixer shall be used.

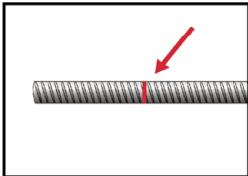

- 3b. Prior to inserting the reinforcing bar into the filled bore hole, the position of the embedment depth shall be marked (e.g. with tape) on the reinforcing bar and insert bar in empty hole to verify hole and depth  $l_v$ .  
The anchor should be free of dirt, grease, oil or other foreign material.

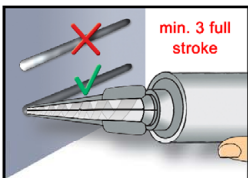

- 3c. Prior to dispensing into the bore hole, squeeze out separately the mortar until it shows a consistent grey or red colour, but a minimum of three full strokes, and discard non-uniformly mixed adhesive components.

### D) Filling the bore hole

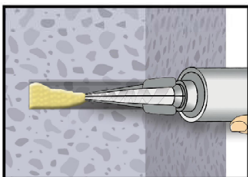

4. Starting from the bottom or back of the cleaned bore hole fill the hole with adhesive, until the level mark at the mixer extension (see below) is visible at the top of the hole. For embedment larger than 190 mm an extension nozzle shall be used. Slowly withdraw the static mixing nozzle and using a piston plugs during injection of the mortar, helps to avoid creating air pockets.

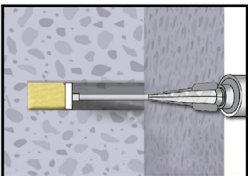

For overhead and horizontal installation and bore holes deeper than 240 mm a piston plug and the appropriate mixer extension must be used.

Observe the gel-/ working times given in Table B3.

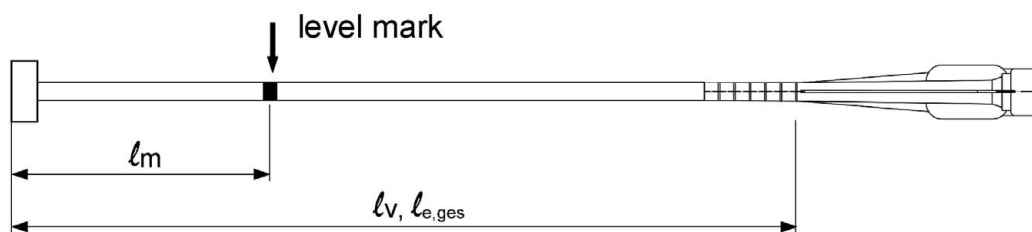

Injection tool must be marked by mortar level mark  $l_m$  and anchorage depth  $l_v$  resp.  $l_{e,ges}$  with tape or marker.

Quick estimation:  $l_m = 1/3 \cdot l_v$

Continue injection until the mortar level mark  $l_m$  becomes visible.

Optimum mortar volume:  $l_m = l_v \text{ resp. } l_{e,ges} \cdot \left( 1,2 \cdot \frac{\phi^2}{d_0^2} - 0,2 \right) \text{ [mm]}$

#### Mungo Injection system MIT700RE for rebar connection

##### Intended Use

Installation instruction: Preparation of bar and cartridge  
Filling the bore hole

#### Annex B 9

## E) Setting the rebar

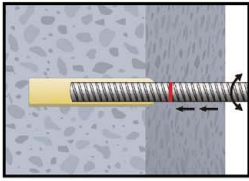

- 5a. Push the reinforcing bar into the bore hole while turning slightly to ensure positive distribution of the adhesive until the embedment depth is reached.

The bar should be free of dirt, grease, oil or other foreign material.

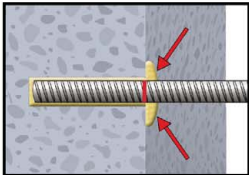

- 5b. Be sure that the bar is inserted in the bore hole until the embedment mark is at the concrete surface and that excess mortar is visible at the top of the hole. If these requirements are not maintained, the application has to be renewed. For horizontal and overhead installation fix embedded part (e.g. with wedges).

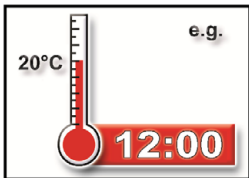

- 5c. Observe gelling time  $t_{gel}$ . Attend that the gelling time can vary according to the base material temperature (see Table B3). Do not move or load the bar until full curing time  $t_{cure}$  has elapsed (attend Table B3).

Mungo Injection system MIT700RE for rebar connection

Intended Use  
Installation instruction: Inserting rebar

Annex B 10

### Minimum anchorage length and minimum lap length

The minimum anchorage length  $\ell_{b,min}$  and the minimum lap length  $\ell_{0,min}$  according to EN 1992-1-1:2004+AC:2010 ( $\ell_{b,min}$  acc. to Eq. 8.6 and Eq. 8.7 and  $\ell_{0,min}$  acc. to Eq. 8.11) shall be multiply by the amplification factor  $\alpha_{Ib}$  according to Table C1.

**Table C1: Amplification factor  $\alpha_{Ib}$  related to concrete class and drilling method**

Concrete class	Drilling method	Bar size	Amplification factor $\alpha_{Ib}$
C12/15 to C50/60	all drilling methods	8 mm to 40 mm ZA-M12 to ZA-M24	1,0

**Table C2: Reduction factor  $k_b$  for all drilling methods**

Rebar $\phi$	Concrete class								
	C12/15	C16/20	C20/25	C25/30	C30/37	C35/45	C40/50	C45/55	C50/60
8 to 40 mm ZA-M12 to ZA-M24	1,0								

**Table C3: Design values of the ultimate bond stress  $f_{bd,PIR}$  in N/mm<sup>2</sup> for all drilling methods and for good conditions**

$$f_{bd,PIR} = k_b \cdot f_{bd}$$

with

$f_{bd}$ : Design value of the ultimate bond stress in N/mm<sup>2</sup> considering the concrete classes, the rebar diameter, the drilling method according to EN 1992-1-1:2004+AC:2010.

(for all other bond conditions multiply the values by 0.7)

$k_b$ : Reduction factor according to Table C2

Rebar $\phi$	Concrete class								
	C12/15	C16/20	C20/25	C25/30	C30/37	C35/45	C40/50	C45/55	C50/60
8 to 32 mm ZA-M12 to ZA-M24	1,6	2,0	2,3	2,7	3,0	3,4	3,7	4,0	4,3
34 mm	1,6	2,0	2,3	2,6	2,9	3,3	3,6	3,9	4,2
36 mm	1,5	1,9	2,2	2,6	2,9	3,3	3,6	3,8	4,1
40 mm	1,5	1,8	2,1	2,5	2,8	3,1	3,4	3,7	4,0

### Mungo Injection system MIT700RE for rebar connection

#### Performances

Amplification factor  $\alpha_{Ib}$ , Reduction factor  $k_b$

Design values of ultimate bond resistance  $f_{bd,PIR}$

### Annex C 1

### Design value of the ultimate bond stress $f_{bd,fi}$ under fire exposure for concrete classes C12/15 to C50/60, (all drilling methods):

The design value of the bond strength  $f_{bd,fi}$  under fire exposure has to be calculated by the following equation:

$$f_{bd,fi} = k_{fi}(\theta) \cdot f_{bd,PIR} \cdot \gamma_c / \gamma_{M,fi}$$

with:  $\theta \leq 278^\circ\text{C}$ :  $k_{fi}(\theta) = 4673,8 \cdot \theta^{-1,598} / (f_{bd,PIR} \cdot 4,3) \leq 1,0$   
 $\theta > 278^\circ\text{C}$ :  $k_{fi}(\theta) = 0$

- $f_{bd,fi}$  Design value of the ultimate bond stress in case of fire in N/mm<sup>2</sup>
- $\theta$  Temperature in °C in the mortar layer.
- $k_{fi}(\theta)$  Reduction factor under fire exposure.
- $f_{bd,PIR}$  Design value of the ultimate bond stress in N/mm<sup>2</sup> in cold condition according to Table C3 considering the concrete classes, the rebar diameter, the drilling method and the bond conditions according to EN 1992-1-1:2004+AC:2010.
- $\gamma_c$  partially safety factor according to EN 1992-1-1:2004+AC:2010
- $\gamma_{M,fi}$  partially safety factor according to EN 1992-1-2:2004+AC:2008

For evidence under fire exposure the anchorage length shall be calculated according to EN 1992-1-1:2004+AC:2010 Equation 8.3 using the temperature-dependent ultimate bond stress  $f_{bd,fi}$ .

### Example graph of Reduction factor $k_{fi}(\theta)$ for concrete classes C20/25 for good bond conditions:

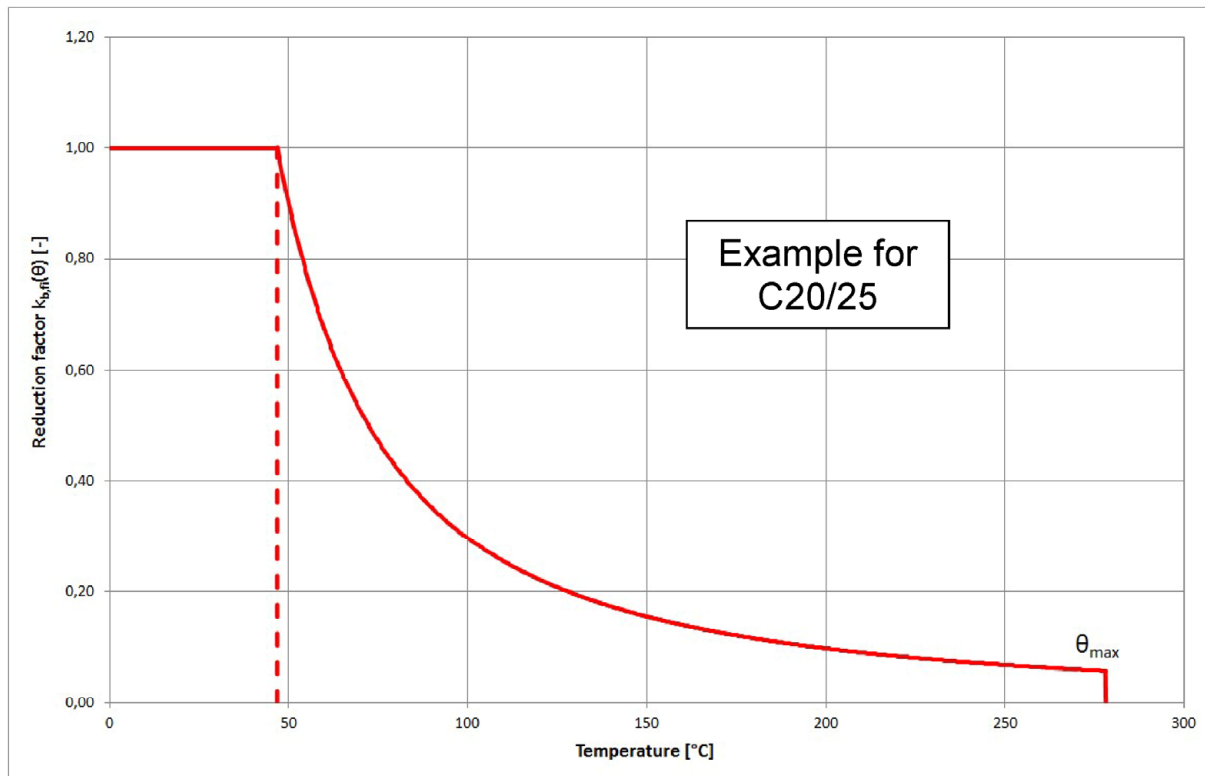

Mungo Injection system MIT700RE for rebar connection

#### Performances

Design value of bond strength  $f_{bd,fi}$  under fire exposure

Annex C 2

**Table C6: Characteristic tension strength for tension anchor ZA under fire exposure, concrete classes C12/15 to C50/60, according to Technical Report TR 020**

Tension Anchor				M12	M16	M20	M24
Steel, zinc plated (ZA vz)							
Characteristic steel strength	R30	$\sigma_{Rk,s,fi}$	[N/mm <sup>2</sup> ]	20			
	R60			15			
	R90			13			
	R120			10			
Stainless Steel (ZA A4 or ZA HCR)							
Characteristic steel strength	R30	$\sigma_{Rk,s,fi}$	[N/mm <sup>2</sup> ]	30			
	R60			25			
	R90			20			
	R120			16			

**Design value of the steel strength  $\sigma_{Rd,s,fi}$  under fire exposure**

The design value of the steel strength  $\sigma_{Rd,s,fi}$  under fire exposure has to be calculated by the following equation:

$$\sigma_{Rd,s,fi} = \sigma_{Rk,s,fi} / \gamma_{M,fi}$$

with:

$\sigma_{Rk,s,fi}$  characteristic steel strength according to Table C4  
 $\gamma_{M,fi}$  partially safety factor according to EN 1992-1-2:2004+AC:2008

**Mungo Injection system MIT700RE for rebar connection**

**Performances**

Design value of the steel strength  $\sigma_{Rd,s,fi}$  for tension anchor ZA under fire exposure

**Annex C 3**